



TO-247-4L

Half-Bridge Evaluation Board

Product Specification

<High Voltage Safety Precautions>

- ◇ Read all safety precautions before use

Please note that this document covers only the SiC MOSFET for TO-247-4L evaluation board (P02SCT3040KR-EVK-001) and its functions. For additional information, please refer to the product specification.

To ensure safe operation, please carefully read all precautions before handling the evaluation board



Depending on the configuration of the board and voltages used,

Potentially lethal voltages may be generated.

Therefore, please make sure to read and observe all safety precautions described in the red box below.

Before Use

- [1] Verify that the parts/components are not damaged or missing (i.e. due to the drops).
- [2] Check that there are no conductive foreign objects on the board.
- [3] Be careful when performing soldering on the module and/or evaluation board to ensure that solder splash does not occur.
- [4] Check that there is no condensation or water droplets on the circuit board.

During Use

- [5] Be careful to not allow conductive objects to come into contact with the board.
- [6] **Brief accidental contact or even bringing your hand close to the board may result in discharge and lead to severe injury or death.**

Therefore, DO NOT touch the board with your bare hands or bring them too close to the board.

In addition, as mentioned above please exercise extreme caution when using conductive tools such as tweezers and screwdrivers.

- [7] If used under conditions beyond its rated voltage, it may cause defects such as short-circuit or, depending on the circumstances, explosion or other permanent damages.
- [8] Be sure to wear insulated gloves when handling is required during operation.

After Use

- [9] The ROHM Evaluation Board contains the circuits which store the high voltage. Since it stores the charges even after the connected power circuits are cut, please discharge the electricity after using it, and please deal with it after confirming such electric discharge.
- [10] Protect against electric shocks by wearing insulated gloves when handling.

This evaluation board is intended for use only in research and development facilities and should be handled **only by qualified personnel familiar with all safety and operating procedures.**

We recommend carrying out operation in a safe environment that includes the use of high voltage signage at all entrances, safety interlocks, and protective glasses.

SiC MOSFET 评估板

TO-247-4L 半桥评估板 产品规格书

在 SiC MOSFET 等功率元器件的评估中，一般会涉及到高电压和大电流，因此要求恰当地构建其评估环境。然而，在探讨新封装时，立即得到最合适评估板是不太可能的。

对此，罗姆设计了这款评估板。评估板采用常见的电路配置--半桥电路，并配有驱动电路、驱动电源、过电流保护电路及栅极信号保护电路等，以便为客户提供最适合的评估环境，使客户可以简单轻松地准备适当的评估条件。

在本用户手册中，将介绍 TO-247-4L 封装用评估板的产品规格。如欲了解使用相关的详细信息，请参考《TO-247-4L 半桥评估板 使用说明书》(No.62UG026C Rev.001, 2019.7)。

1. 外观

图 1 为评估板的外观，表 1 为评估板的尺寸和重量。



图 1. 顶视图

表 1. 尺寸和重量

长	150	mm
宽	150	
高	65	kg
重量	0.335	

2. 特点

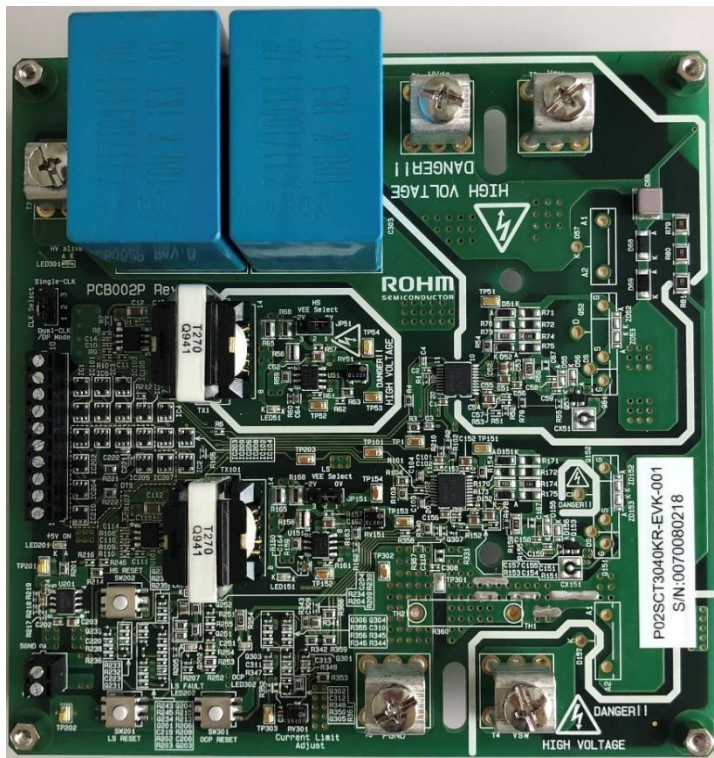
评估板的主要特点如下：

- 可评估 TO-247-4L 和 TO-247-3L
- 单一电源（+12V）工作
- 最大 150A 的双脉冲测试
- 最大 500kHz 的开关工作
- 支持各种电源拓扑（Buck, Boost, Half-Bridge）
- 内置栅极驱动用隔离电源，可通过可变电阻调整（+12V~+23V）
- 可通过跳线引脚切换栅极驱动用负偏压和零偏压
- 可防止上下臂同时导通
- 内置过电流保护功能（DESAT, OCP）

3. 产品规格

评估板的规格如下，表 2 为可订购的规格一览表。



表 2. 规格一览表

元器件	封装	负偏压设置	产品规格
SCT3040KR	TO-247-4L	0V	P02SCT3040KR-EVK-001

4. 功能方框图

图 2 为评估板的功能方框图。该评估板具有四大主要功能：

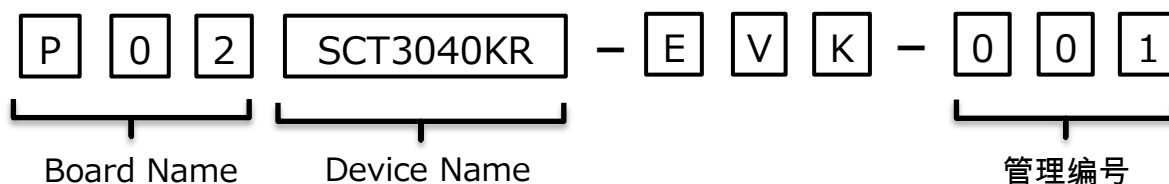
- 驱动类...用来对功率元器件进行开关的电路
- 控制类...用来控制输入信号的电路
- 保护类...用来防止功率元器件损坏的电路
- 功率元器件类...用来控制 SiC MOSFET 和缓冲电路的高电压、大电流等的部件

表 3 为各功能的详细说明，表 4 为输入输出信号线的定义。图中的 HS 表示上臂用，LS 表示下臂用，因此在符号(Symbol)中省略。



图 2. 功能方框图

表 3. 各功能的详细说明

	功能	符号	详细说明
驱动类	Gate Driver	GD	栅极驱动 IC (BM6101FV-C)
	Gate Power	GP	栅极驱动电路用电源电路 (BD7F200FV-C)
	Gate Adjust	GADJ	用来调整 MOSFET 开关速度的调整电路 可单独调整导通和关断
	Driver Source Select	DSSEL	根据 3L 和 4L 选择栅极驱动电路返回线的电路 选择 3L,4L 不同的源极端, 接入驱动回路。
控制类	Low Drop-Out regulator	LDO	控制电路用电源 (BD450M2WEFJ) 控制逻辑电平输入信号的电路用电源
	Clock Select	CSEL	驱动信号切换电路 上下臂同时控制 CLK 信号和上下臂单独控制 CLK 信号的切换
	Dead Time setup	DTS	死区时间调整电路 上下臂同时控制 CLK 信号时的上下臂同时 OFF 死区时间设置
	Shoot Through Prevention	STP	上下臂同时导通防止电路 防止上下臂同时控制 CLK 信号时的同时导通
保护类	Gate Surge Clamp	GSC	栅极-源极间浪涌电压钳位电路 通过 SBD 限制正浪涌和负浪涌
	VEE2 Select	VEESEL	VEE2 电压设置电路 通过设置引脚选择 0V/-2V
	GND Select	GSEL	OCP GND 电平设置电路 通过 VEE2 电压的设置选择 OCP 电路的 GND 连接
	Over Current Protection	OCP	过电流保护电路 (整体) 检测 LS 端源极电流峰值,当超过基准值时发出 FLT 信号 上下臂均关闭锁存, 并将驱动器 IC 置于 Disable 状态
	Device Under Test	DUT	评估用 MOSFET 和肖特基势垒二极管 (SBD)
	Desaturation Circuit	DESAT	过电流保护电路 (单独) 检测 MOSFET 的 Vds 电压, 当达到基准值以上时, 发出 FLT 信号 一端检测时上下臂均关闭锁存, 并将驱动器 IC 置于 Disable 状态
	Fault Indicator	FID	OCP 状态、DESAT 状态 显示电路 FLT 信号 H 时 LED(红)灯亮, 并将驱动器 IC 设置为 Disable (禁用) 状态
	Current Sense	CS	电流感应电路 (4.7mΩ 感应电阻)
	Discharge Resistor	DCR	放电电阻电路 (68kΩ×5 串联) 当 HVdc OFF 后, 将输入电容器的电荷放电

表 3. 各功能的详细说明 (续)

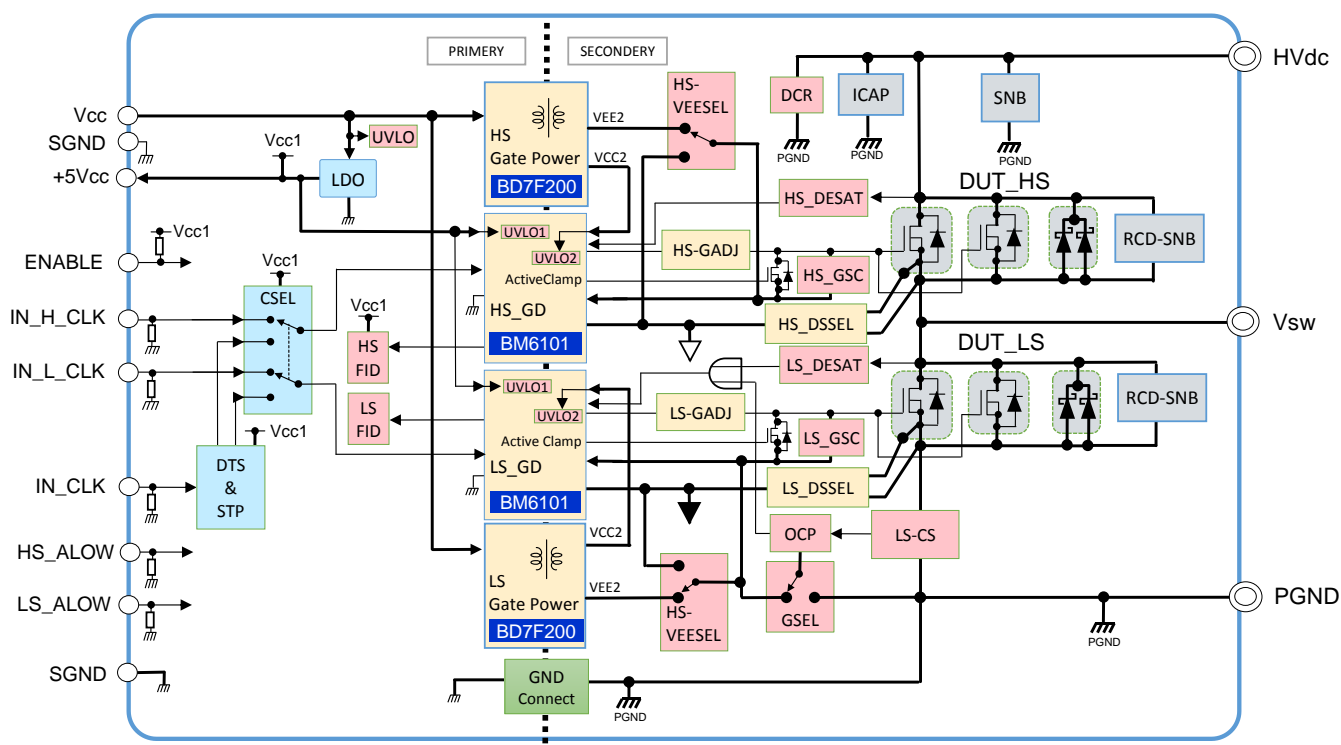
	功能	符号	详细说明
功率元 器件类	Input Capacitor	ICAP	输入滤波电容器
	Snubber Capacitor	SNB	一并连接于上臂和下臂的旁路电容器
	RDC Snubber Circuit	RCD_SNB	分别连接于上下臂的非放电型 RCD 缓冲电路
	Device Under Test	DUT	评估用 MOSFET 和 SBD

表 4. 输入输出信号线的定义

连接器	引脚	符号	I/O	详细说明
CN201	01	ENABLE	I	连接于上下臂的驱动器 IC ENA 引脚 (无法单独控制)
	02	SGND	--	输入信号端 GND
	03	IN_CLK	I	上下臂 MOSEFT 对称 ON/OFF 的信号
	04	IN_L_CLK	I	下臂 MOSFET 的 ON/OFF 信号
	05	SGND	--	输入信号端 GND
	06	IN_H_CLK	I	上臂 MOSFET 的 ON/OFF 信号
	07	HS_ALOW	I	"IN_H_CLK"信号的逻辑反相信号
	08	+5Vcc	--	控制用电源(+5V)的输出引脚
	09	LS_ALOW	I	"IN_L_CLK"信号的逻辑反相信号
	10	SGND	--	输入信号端 GND
CN202	01	Vcc	--	驱动器 IC 和内部控制用电源引脚
	02	SGND	--	输入信号端 GND
JP1	01	DUAL/DP	I	设置为"Dual-CLK/DP Mode"状态的信号
	02	SGND	--	输入信号端 GND
	03	SINGLE	I	设置为"Single-CLK Mode"状态的信号
T1	--	HVdc	--	高电压输入输出引脚
T2, T4	--	Vsw	--	上臂 MOSFET 的源极引脚和下臂 MOSFET 的漏极引脚
T3, T5	--	PGND	--	Power GND 引脚

5. 电气特性

表 5 为最大额定值，表 6 为推荐工作条件。

表 5. 最大额定值

参数	符号	Min.	Max.	单位	备注
Input Voltage DC	V_{HVdc}		1200	V	
Input Voltage slew rate	SR_{HVdc}		50	V/ μ s	Limited by input film capacitor
Output Voltage	V_{OUT}		1200	V	
Vcc Supply Voltage	V_{CC}	5.0	20	V	for isolated gate power and internal logic
Input Signal Voltage	V_{ENABLE} V_{HS_ALOW} V_{LS_ALOW} $V_{IN_H_CLK}$ $V_{IN_L_CLK}$ V_{IN_CLK}	- 0.3	5.3	V	
+5Vcc Output Current	I_{5Vcc}		20	mA	Auxiliary Power Source
Storage Temperature	T_{STG}	-10	40	$^{\circ}$ C	Limited by input film capacitor

表 6. 推荐工作条件

参数	符号	Min.	TYP.	Max.	单位	备注
Input Voltage DC	V_{HVdc}			900	V	
Output Voltage	V_{OUT}			900	V	
Vcc Supply Voltage	V_{CC}	10	12	15	V	
Output Current	I_{OUT}			30	A	
Double Pulse Current	I_{DP}			150	A	
CLK signal Pulse width	t_{PWDT}			10	μ s	LS only, 0V bias
CLK Signal frequency	$f_{IN_xx_CLK}$			500	kHz	
Input signal Low level voltage	$V_{IN_H_CLK}$ $V_{IN_L_CLK}$ V_{IN_CLK} V_{HS_ALOW}	0		1.5	V	
Input signal High Level voltage	V_{LS_ALOW} V_{ENABLE}	3.5		5.1	V	
Operating Temperature	T_{OPR}		25		$^{\circ}$ C	
Cumulative operating Time	t_{CUM}		100		Hrs.	

6. 电路图

图 3 为安装 SCT3040KR 后的电路图。



图 3: P02SCT3040KR-EVK-001 电路图

7. BOM

表 7. 物料清单

Device	Mounted	Symbol	Parts Number	Values	Manufacture	Package Size [mm]
PCB	--	--	PCB002P Rev.D	RF4, 4layer, 3mm Thickness	ROHM	150 x 150
IC	Mounted	U1,U101	BD7F200EFJ-LB2	PWM IC	ROHM	HTSOP-J8
IC	Mounted	U2,U102	BM6101FV-CE2	Driver IC	ROHM	SSOP-20W
IC	Mounted	U201	BD450M2WEFJ-CE2	LDO(5V,0.2A)	ROHM	HTSOP-J8
IC	Mounted	U51,U151	S-19700A00A-E8	LDO(20V,0.4A)	SII	HSOP-8A
IC	Mounted	IC1,IC2,IC3,IC4, IC101,IC102,IC103,IC104, IC203,IC204	BU4S11G2TR	NAND(single)	ROHM	SSOP-5
IC	Mounted	IC5,IC105,IC201,IC202, IC207,IC208,IC209,IC210	BU4SU69G2TR	INV(single)	ROHM	SSOP-5
IC	Mounted	IC205,IC206	BU4S584G2TR	Schmitt INV(S)	ROHM	SSOP-5
Diode	Mounted	D1,D51,D52,D101,D151, D152,D202,D203,D204	RB160MM-40TR	40V,1A	ROHM	PMDU
Diode	Mounted	D59,D159	RB160VAM-60TR	60V,1A	ROHM	TUMD2M
Diode	NOP	D55,D56,D155,D156	RB160VAM-60TR	60V,1A	ROHM	TUMD2M
Diode	Mounted	D58,D158	RB168VAM150TR	150V,1A	ROHM	TUMD2M
Diode	Mounted	D53,D54,D153,D154, D68,D69,D168,D169	RFN1LAM7STR	700V,0.8A	ROHM	PMDTM
Diode	Mounted	D201	RF302LAM2STR	200V,3A	ROHM	PMDTM
Diode	NOP	D57,D157	DUT		TBD	TO-247
Transistor	NOP	Q51,Q151	DUT		TBD	TO-247-4L
Transistor	NOP	Q52,Q152	DUT		TBD	TO-247-3L
Transistor	Mounted	Q53,Q153	RSR030N06TL	60V,3A	ROHM	SC-96
Transistor	Mounted	Q201,Q202,Q203,Q204, Q231,Q232,Q233,Q234, Q301,Q302,Q303,Q304, Q306,Q251	2SCR523EBTL	50V,0.1A	ROHM	SC-89
Transistor	Mounted	Q305,Q307,Q252	2SAR523EBTL	50V,0.1A	ROHM	SC-89
Zener Diode	Mounted	ZD1,ZD101	TFZVTR15B	15V, 20mA	ROHM	TUMD2M
Zener Diode	Mounted	ZD51,ZD151	TFZVTR2.0B	2.0V, 20mA	ROHM	TUMD2M
Zener Diode	NOP	ZD52,ZD152	TFZVTR2.0B	2.0V, 20mA	ROHM	TUMD2M
Zener Diode	NOP	ZD53,ZD153	TFZVTR22B	22V, 5mA	ROHM	TUMD2M
LED	Mounted	LED201,LED51,LED151	SML-D12P8WT86L	Green, 20mA	ROHM	1.6 x 0.8
LED	Mounted	LED202,LED232,LED301, LED302	SML-D12U8WT86Q	Red, 20mA	ROHM	1.6 x 0.8
Switch	Mounted	SW201,SW202,SW301	SMTE3-01E-Z	SPST, 24V,30mA	Copal	6.8 x 7.0
Jumper pin	Mounted	JP201,JP51,JP151	929647-02-03-EU	Male,3-pin	3M	---
Jumper-pin shunt	Mounted	JP202,JP52,JP152	QPC02SXGN-RC	2-pin, black	Sullins	2.54 x 5
Terminal	Mounted	T1,T2,T3,T4,T5	7808	M5, 30A, 6P	Keystone	12 x 12
Terminal	Mounted	CN201	OSTTE100104	10pin, black	ON-SHORE	36 x 7
Terminal	Mounted	CN202	OSTTE020104	2pin, black	ON-SHORE	8 x 7
Test Pin	Mounted	TP1,TP101,TP201,TP202, TP203,TP51,TP52,TP53, TP54,TP151,TP152,TP153, TP154,TP302,TP303	HK-2-G	SMD	Mac8	3.2 x 1.6
Test Pin	NOP	TP301	HK-2-G	SMD	Mac8	3.2 x 1.6
Connector	NOP	CX51,CX52,CX151,CX152	73415-2061	Jack, SMD mount	Molex	φ3.45 3.45 x 3.45
Transformer	Mounted	TX1,TX101	EE2225 04398-T256	2-output	SUMIDA	20 x 18
Trimmer	Mounted	RV51,RV151	SM-3TW10kohm(103)	10k, 1/8W, 11turns	Copal	3.9 x 3.5
Trimmer	Mounted	RV301	SM-31W1kohm(102)	1k, 1/8W, 5turns	Copal	3.9 x 3.5

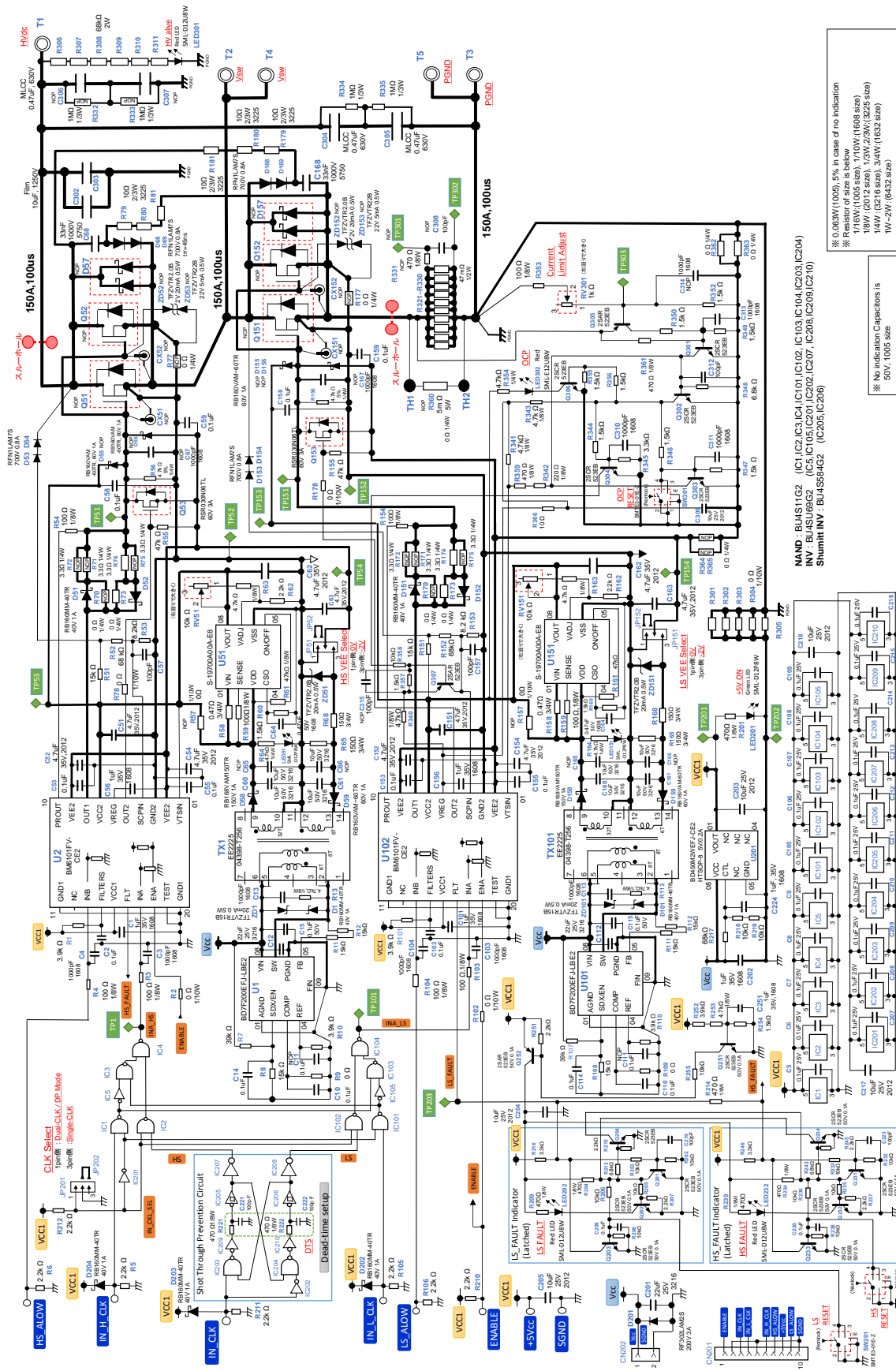
表 7. 物料清单

Device	Mounted	Symbol	Parts Number	Values	Manufacture	Package Size [mm]
Resistor	Mounted	R5,R6,R105,R106, R62,R162,R207, R210,R211,R212,R237, R215,R245,R251	MCR01MZPF2201	2.2k, 1/16W	ROHM	1.0 x 0.5
Resistor	Mounted	R366	MCR01MZPF10R0	10, 1%, 1/16W	ROHM	1.0 x 0.5
Resistor	Mounted	R52,R152,R217	MCR01MZPF6802	68k, 1%, 1/16W	ROHM	1.0 x 0.5
Resistor	Mounted	R8,R108,R51,R151, R11,R12,R111,R112	MCR01MZPF1502	15k, 1%, 1/16W	ROHM	1.0 x 0.5
Resistor	Mounted	R213,R243,R348	MCR01MZPF6801	6.8k, 1%, 1/16W	ROHM	1.0 x 0.5
Resistor	Mounted	R9,R109	MCR01MZPJ000	0ohm	ROHM	1.0 x 0.5
Resistor	Mounted	R10,R110,R252, R1,R101	MCR01MZPF3901	3.9k, 1%, 1/16W	ROHM	1.0 x 0.5
Resistor	Mounted	R345,R216,R246	MCR01MZPF3301	3.3k, 1%, 1/16W	ROHM	1.0 x 0.5
Resistor	Mounted	R55,R155,R61,R161	MCR01MZPF4702	47k, 1%, 1/16W	ROHM	1.0 x 0.5
Resistor	Mounted	R7,R107	MCR01MZPF3902	39k, 1%, 1/16W	ROHM	1.0 x 0.5
Resistor	Mounted	R53,R153	MCR01MZPF8201	8.2k, 1%, 1/16W	ROHM	1.0 x 0.5
Resistor	Mounted	R60,R160,R355,R356, R344,R346,R347,R357, R254,R349,R352,R350	MCR01MZPF1501	1.5k, 1%, 1/16W	ROHM	1.0 x 0.5
Resistor	Mounted	R202,R203,R205,R206, R232,R233,R235,R236, R218,R219,R358,R255, R208,R238	MCR01MZPF1002	10k, 1%, 1/16W	ROHM	1.0 x 0.5
Resistor	Mounted	R2,R102,R78,R178,R301, R302,R303,R304,R305	MCR03EZPJ000	0ohm	ROHM	1.6 x 0.8
Resistor	Mounted	R3,R4,R103,R104,R54, R154,R59,R159,R353	MCR10EZPJ101	100, 5%, 1/8W	ROHM	2.0 x 1.25
Resistor	Mounted	R342	MCR10EZPF2200	220, 1%, 1/8W	ROHM	2.0 x 1.25
Resistor	Mounted	R13,R113,R63,R163, R341,R343,R253,R340	MCR10EZPF4701	4.7k, 1%, 1/8W	ROHM	2.0 x 1.25
Resistor	Mounted	R201,R204,R209,R214, R234,R239,R221,R222, R359,R361	MCR10EZPF4700	470, 1%, 1/8W	ROHM	2.0 x 1.25
Resistor	Mounted	R65,R165,R68,R168	LTR18EZPF1500	150, 1%, 3/4W	ROHM	1.6 x 3.2
Resistor	Mounted	R58,R158	LTR18EZPFLR470	0.47, 1%, 1W	ROHM	1.6 x 3.2
Resistor	Mounted	R56,R156,R354, R64,R164	MCR18EZPJ472	4.7k, 5%, 1/4W	ROHM	3.2 x 1.6
Resistor	Mounted	R74,R174	ESR18EZPJ3R3	3.3, 5%, 1/2W	ROHM	3.2 x 1.6
Resistor	Mounted	R73,R173,R362,R363	MCR18EZPJ000	0ohm	ROHM	3.2 x 1.6
Resistor	Mounted	R334,R335	KTR25JZPJ105	1M, 5%, 1/3W	ROHM	3.2 x 2.5
Resistor	Mounted	R306,R307,R308,R309, R310,R311	LTR100JZPJ683	68k, 5%, 2W	ROHM	3.2 x 6.4
Resistor	Mounted	R321,R322,R323,R324, R325,R326,R327,R328, R329,R330	LTR10EVHFSR047	47m, 1%, 1/2W	ROHM	1.2 x 2.0
Resistor	NOP	R57,R157	MCR03EZPJ000	0ohm	ROHM	1.6 x 0.8
Resistor	NOP	R331	MCR10EZPF4700	470, 1%, 1/8W	ROHM	2.0 x 1.25
Resistor	NOP	R70,R170,R77,R177,R364,R365	MCR18EZPJ000	0ohm	ROHM	3.2 x 1.6
Resistor	NOP	R72,R75,R172,R175,R71,R171	ESR18EZPJ3R3	3.3, 5%, 1/4W	ROHM	3.2 x 1.6
Resistor	NOP	R332,R333	KTR25JZPJ105	1M, 5%, 1/3W	ROHM	3.2 x 2.5
Resistor	NOP	R360	PWR4412-2S-D-R0050F	5m, 1% 5W	BOURNS	2.1 x 4.8
Resistor	Mounted	R79,R80,R81, R179,R180,R181	ESR25JZPJ100	10, 5%, 2/3W	ROHM	3.2 x 2.5

表 7. 物料清单

Device	Mounted	Symbol	Parts Number	Values	Manufacture	Package Size [mm]
Capacitor	Mounted	C2,C102,C10,C14,C110, C114,C53,C55,C153,C155, C5,C6,C7,C8,C9,C105, C106,C107,C108,C109, C207,C208,C209,C210, C211,C212,C213,C214, C215,C216,C206, C220,C58,C59,C158, C159,C15,C115	CGA2B3X7R1H104K050BB	0.1u,50V,X7R	TDK	1.0 x 0.5
Capacitor	Mounted	C57,C157,C219,C223, C221,C222,C312	CGA2B2C0G1H101J050BA	100p,50V,C0G	TDK	1.0 x 0.5
Capacitor	Mounted	C202,C56,C156, C224,C1,C101,C251	CGA3E1X7R1V105K080AC	1u,35V,X7R	TDK	1.6 x 0.8
Capacitor	Mounted	C3,C4,C13,C103,C104, C113,C310,C311,C313	CGA3E2C0G1H102J080AA	1000p,50V,C0G	TDK	1.6 x 0.8
Capacitor	Mounted	C64,C164	CGA3E3X7R1H474K080AB	0.47u,50V,X7R	TDK	1.6 x 0.8
Capacitor	Mounted	C51,C52,C54,C151,C152, C154,C62,C63,C162,C163	CGA4J1X7R1V475K125AC	4.7u,35V,X7R	TDK	2.0 x 1.25
Capacitor	Mounted	C203,C204,C205, C217,C218,C309	CGA4J1X7S1E106KT0Y0N	10uF,25V,X7S	TDK	2.0 x 1.25
Capacitor	Mounted	C60,C61,C160,C161	CGA5L3X5R1H106K160AB	10uF,50V,X5R	TDK	3.2 x 1.6
Capacitor	Mounted	C12,C112,C201	C3216X5R1E226M160AB	22uF,25V,X5R	TDK	3.2 x 1.6
Capacitor	Mounted	C304,C305	CGA9P1X7T2J474M250KC	0.47u,630V,X7T	TDK	5.7 x 5.0
Capacitor	Mounted	C302,C303	B32776G1106K000	10uF,1250V	TDK	42 x 28
Capacitor	Mounted	C68,C168	C5750C0G3A333J280KC	33000pF,1000V	TDK	5.7 x 5.0
Capacitor	NOP	C11,C111	CGA2B3X7R1H104K	0.1u,50V,X7R	TDK	1.0 x 0.5
Capacitor	NOP	C308,C315	CGA2B2C0G1H101J050BA	100p,50V,C0G	TDK	1.0 x 0.5
Capacitor	NOP	C314,C67,C167	CGA3E2C0G1H102J080AA	1000p,50V,C0G	TDK	1.6 x 0.8
Capacitor	NOP	C65,C66,C165,C166	CGA5L3X5R1H106K160AB	10uF,50V,X5R	TDK	3.2 x 1.6
Capacitor	NOP	C306,C307	CGA9P1X7T2J474M250KC	0.47u,630V,X7T	TDK	5.7 x 5.0

8. PCB 布局

本评估板为 4 层结构，图 4. (a)~(d)表示各层的版图布局。



图 4. (a) 顶层 (顶视图)



图 4. (b) 第二层 (顶视图)

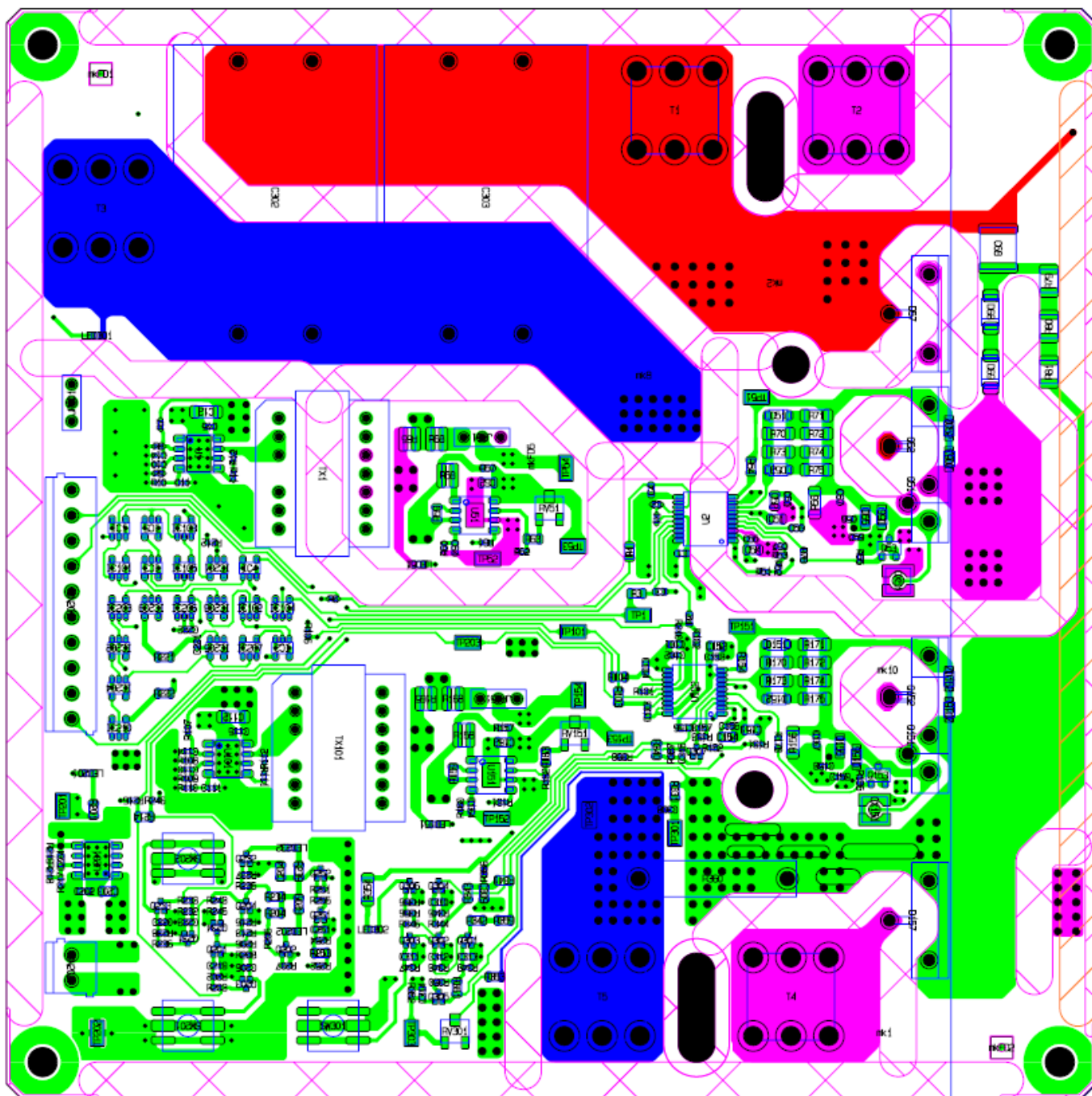

图 4. (c) 第三层 (顶视图)

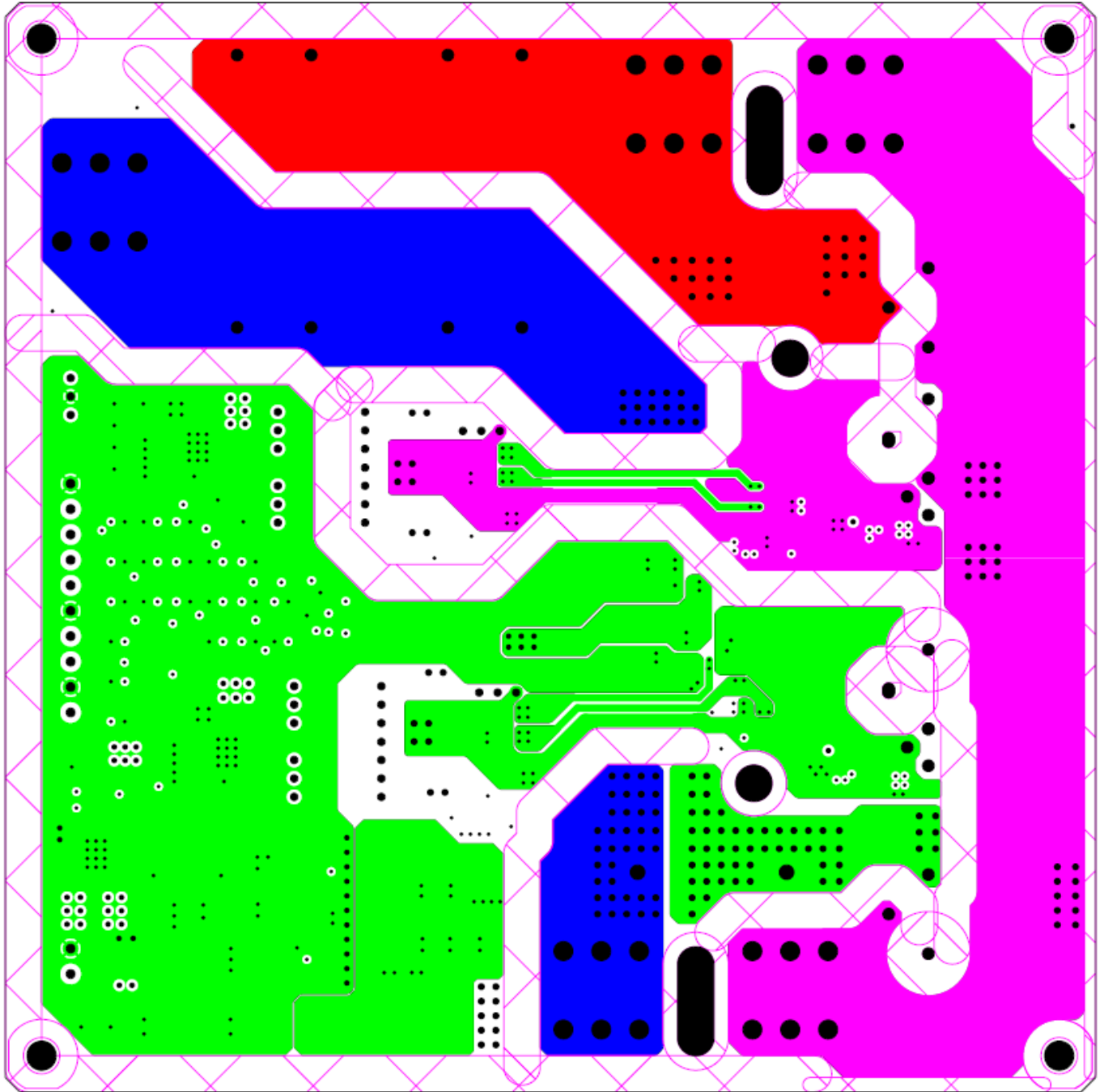

图 4. (d) 底层 (顶视图)

9. 注意事项

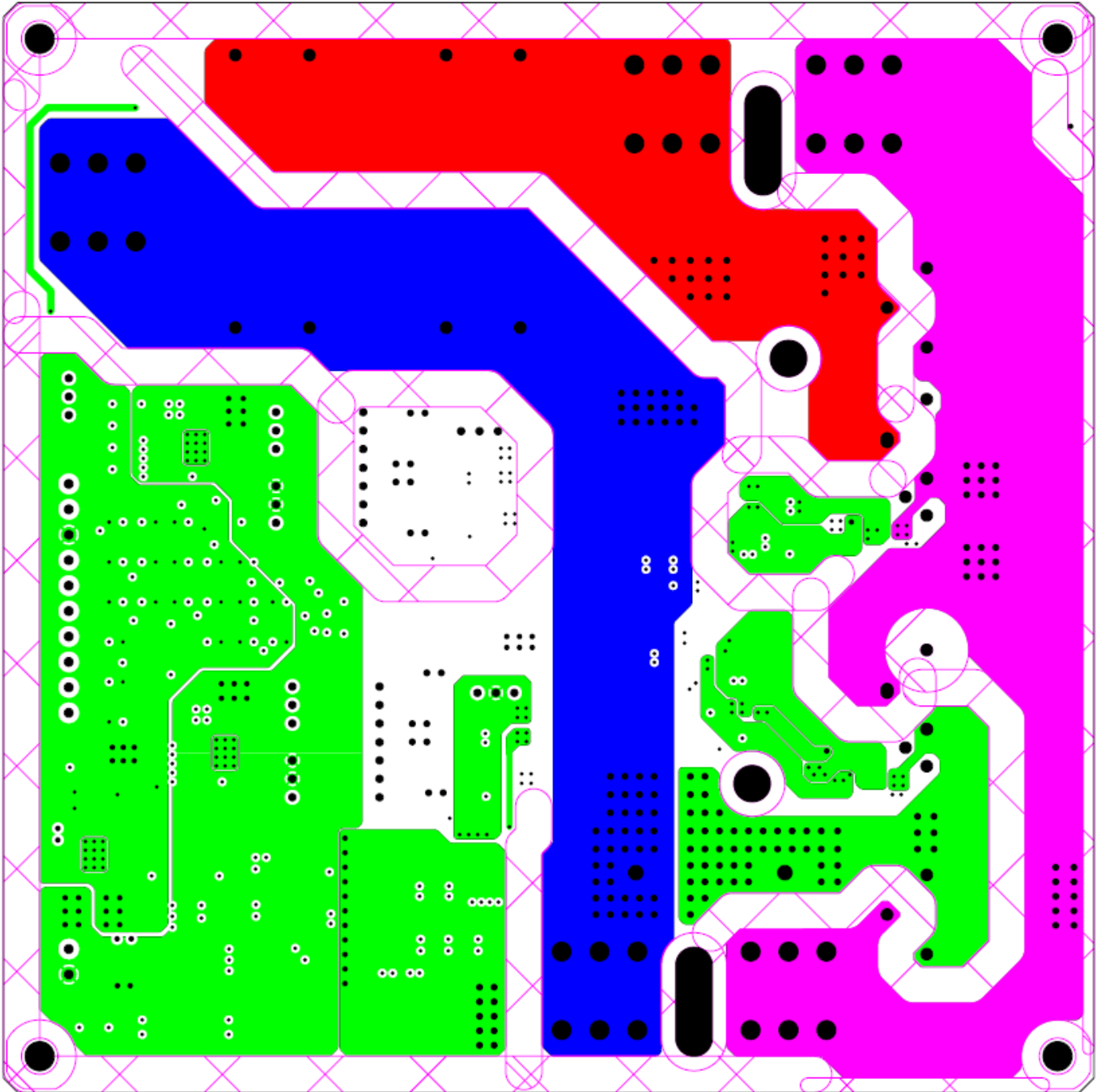
本评估板要处理数百伏的电压，因此需要始终注意避免因故障带来危险。故障不仅包括本评估板产生的问题，还包括布线误接和施加规定外的电压等错误操作引发的问题。

表 8 中列出了需要特别注意的事项，在使用之前，请采取全备的故障预防措施，以预防包括这些注意事项在内的任何故障发生。

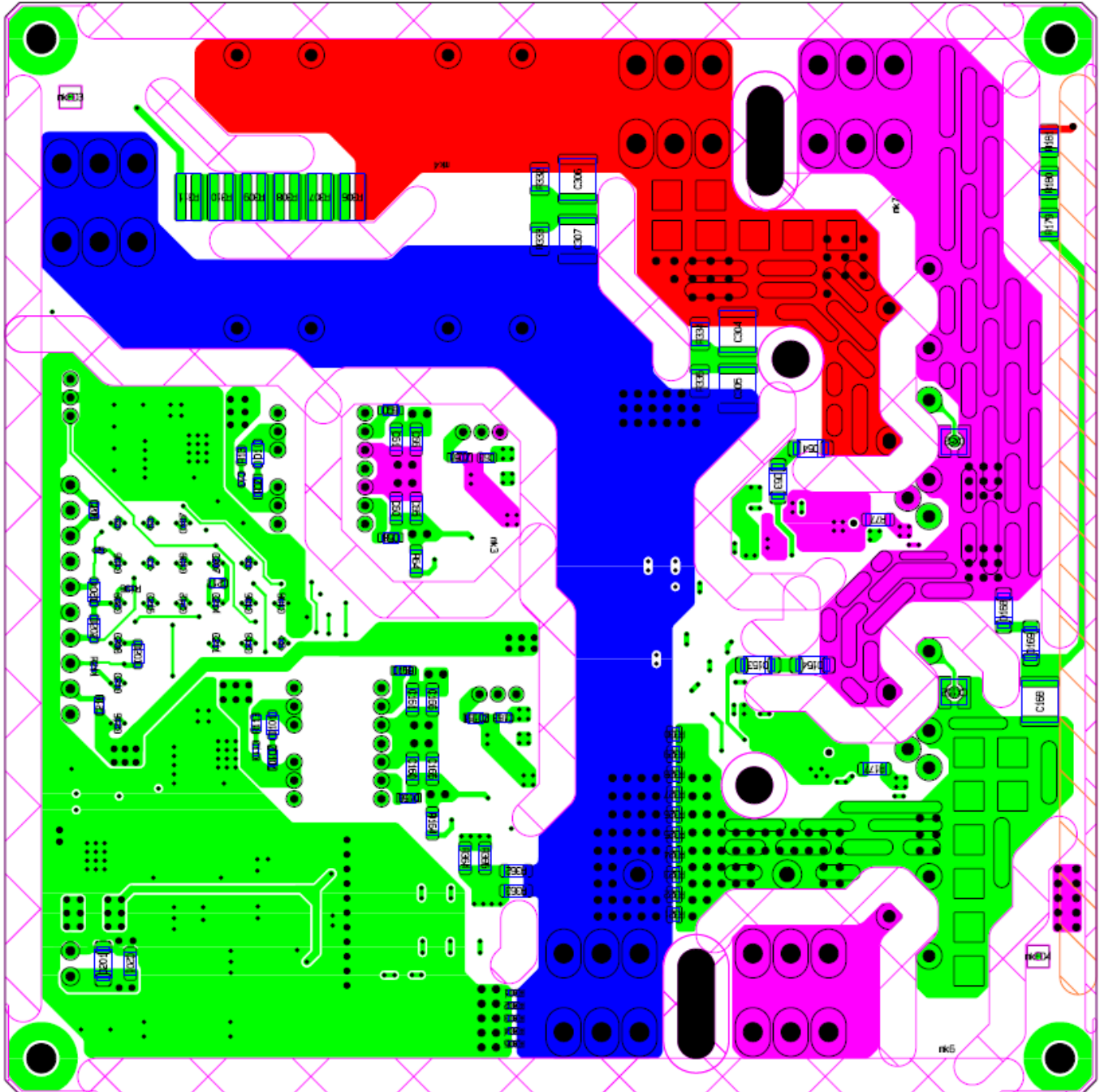
表 8. 常见故障一览表

功能	项目	详细说明
DCR	LED 灯不亮	对 HVdc-PGND 引脚施加电压后，请确认 LED301(红色)灯是亮的。灯不亮时请确认施加电压源和布线等情况。(当输入输出电压达到约 20V 以上时灯亮。)
FID	LED 灯不亮	在 FAULT 状态下，即使输入 CLK 信号，也不发送 MOSFET 的栅极驱动信号，且 LED202、LED232(红色)灯亮。 在未安装 MOSFET 的状态下输入 CLK 信号(20μs 以上)时灯亮。
OCP	零偏压工作时的检测电平	当检测出 OCP 时 LED301(红色)灯亮，但零偏压工作时检测电平非常高，约为 170A，不能完全避免危险。在施加 HVdc 时，请密切监视以确保异常时能够立即切断电源。
	超出最大脉冲宽度时，FAULT LED 亮	按照初期设置 (0V 偏置)，在 LS 端进行双脉冲试验时，最大脉冲宽度超过 10 μs，LS 端漏极电流超过 30A 的话，会发出 FLT 信号，“LS_FAULT” LED 等会亮。如果需要加 10μs 以上的脉宽并且漏电流超过 30A 的话，请改变 VTSIN 信号的 Level-Shift 值 具体参考产品使用手册。
HVdc Vsw	布线错误 施加规定外电压	严禁施加超过规定值(1200V)的电压，请确保布线等的连接无误。另外，运行过程中切勿触摸。
Vcc	布线错误 施加规定外电压	请确认布线情况以避免误用，Vcc 请勿施加正负反向电压。但是，由于有反接用二极管，因此，请将 Vcc 电源的 OPC 设置为 1A~3A。 另外，如果施加规定电压之外的电压，可能会导致故障，请充分确认后再操作。
SNB RDC_SNB	MLCC 烧损	使用的 MLCC 容易发生机械应力导致的开裂等短路故障。请小心操作，且勿对评估板施加过度冲击。 如果在施加电压时有任何担心之处，请务必立即采取措施，比如切断施加的电压，以避免危险。

以 上

Notes

- 1) The information contained herein is subject to change without notice.
- 2) Before you use our Products, please contact our sales representative and verify the latest specifications :
- 3) Although ROHM is continuously working to improve product reliability and quality, semiconductors can break down and malfunction due to various factors.
Therefore, in order to prevent personal injury or fire arising from failure, please take safety measures such as complying with the derating characteristics, implementing redundant and fire prevention designs, and utilizing backups and fail-safe procedures. ROHM shall have no responsibility for any damages arising out of the use of our Products beyond the rating specified by ROHM.
- 4) Examples of application circuits, circuit constants and any other information contained herein are provided only to illustrate the standard usage and operations of the Products. The peripheral conditions must be taken into account when designing circuits for mass production.
- 5) The technical information specified herein is intended only to show the typical functions of and examples of application circuits for the Products. ROHM does not grant you, explicitly or implicitly, any license to use or exercise intellectual property or other rights held by ROHM or any other parties. ROHM shall have no responsibility whatsoever for any dispute arising out of the use of such technical information.
- 6) The Products specified in this document are not designed to be radiation tolerant.
- 7) For use of our Products in applications requiring a high degree of reliability (as exemplified below), please contact and consult with a ROHM representative : transportation equipment (i.e. cars, ships, trains), primary communication equipment, traffic lights, fire/crime prevention, safety equipment, medical systems, servers, solar cells, and power transmission systems.
- 8) Do not use our Products in applications requiring extremely high reliability, such as aerospace equipment, nuclear power control systems, and submarine repeaters.
- 9) ROHM shall have no responsibility for any damages or injury arising from non-compliance with the recommended usage conditions and specifications contained herein.
- 10) ROHM has used reasonable care to ensure the accuracy of the information contained in this document. However, ROHM does not warrants that such information is error-free, and ROHM shall have no responsibility for any damages arising from any inaccuracy or misprint of such information.
- 11) Please use the Products in accordance with any applicable environmental laws and regulations, such as the RoHS Directive. For more details, including RoHS compatibility, please contact a ROHM sales office. ROHM shall have no responsibility for any damages or losses resulting non-compliance with any applicable laws or regulations.
- 12) When providing our Products and technologies contained in this document to other countries, you must abide by the procedures and provisions stipulated in all applicable export laws and regulations, including without limitation the US Export Administration Regulations and the Foreign Exchange and Foreign Trade Act.
- 13) This document, in part or in whole, may not be reprinted or reproduced without prior consent of ROHM.



Thank you for your accessing to ROHM product informations.
More detail product informations and catalogs are available, please contact us.

ROHM Customer Support System

<http://www.rohm.com/contact/>